



USER MANUAL



VESTA2 GB2 MONITOR



INTRODUCTION

First and foremost we would like to thank you for purchasing this product. Our commitment to satisfying our customers can be seen from our ISO-9001 certification and from the manufacturing of products like this one. Its advanced technology and exacting quality control will ensure that customers and users enjoy the many features this system offers. To obtain the maximum benefit from these features and a properly wired installation, we kindly recommend that you spend a few minutes of your time reading this manual.

CONTENTS

Introduction.....2

Contents.....2

Safety precautions.....2

Characteristics.....3

System operation.....3

Monitor description.....

 Description.....4

 Function and menu buttons.....4

 Status LEDs.....4

 Connection terminals.....4

 Configuration dip switch.....4

 Setting the monitor's address codes.....5

Installation of the monitor in a surface box.....6

Installation of the monitor in an embedding box.....7

Operation.....

 Description.....8

 1.1 Receiving a call from the door panel.....8

 1.2 The call is unanswered (resident unavailable).....9

 1.3 Ending a call from the door panel.....9

 1.4 Answering a call from the door panel.....9

 1.5 "Doctor mode" function (automatic door opening).....10

Screen and monitor volume settings menu (contrast, brightness, colour and monitor volume).....11

User menu.....

 Accessing the menu.....12

 1. Displaying door panel/camera images.....13

 1.1 Displaying images from the door panels.....13

 1.2 Displaying camera images (D-CAM-GB2 module required).....14

 2. Intercom calls.....15

 2.1 Intercom calls between apartments.....15-16

 2.2 Calling the Guard monitor.....17

 2.3 Intercom calls within an apartment.....18

 3. Do not disturb mode.....19-20

 4. Divert calls mode.....20-21

 5. Settings (ringtone, ring volume, auto switch-on time and language selection).....22-24

 6. About (information, "restore" default setting and access to installer setup).....24-25

Second lock release menu (menu to activate lock release 1 or lock release 2).....26

Monitor cleaning.....26



Notes.....27

Annex: Image memory (only for installations with MM-GB2 module and FA-GB2 power supply).....29-30









SAFETY PRECAUTIONS

- Do not use excessive force when tightening the monitor's connection block screws.
- **Always disconnect the power supply** before making modifications to the equipment.
- The installation and handling of these devices must be carried out by **authorised personnel**.
- All of the wiring must run at least **40cm away from any other wiring**.
- Install the monitor in a dry and protected place without risk of drip or water projections.
- Do not place in humid, dusty or smoky locations, or near sources of heat.
- Before connecting the system to the mains, check the connections between the door panel, power supply, distributors and monitors.
- Always follow the instructions contained in this manual.

CHARACTERISTICS

- Hands-free monitor.
- 4.3" TFT colour screen.
- Monitor with simple installation (non-polarised 2 wire BUS).
- Capacitive buttons to access and select menu functions:
 - User menu:**
 - Display door panel images.
 - Display camera images (D-CAM-GB2 module required).
 - Intercom calls between apartments.
 - Intercom calls within an apartment.
 - Calls to the Guard monitor.
 - Do not disturb mode (door panel or intercom calls are not received).
 - Divert call (GSM-GB2 module required).
 - Settings: Ringtone, ring volume, auto switch-on time and language.
 - About: Information, "restore" default setting and access to installer setup.
 - Installer setup:**
 - Monitor as master or (Slave 1, Slave 2 or slave 3). Up to 4 monitors per apartment.
 - Guard monitor.
 - Activate the menu to open the second lock release.
 - Allow view the menu when the Bus is busy.
 - Activate intercom calls between apartments.
 - Screen and volume settings menu:** (during auto switch-on or communication).
 - Contrast.
 - Brightness
 - Colour.
 - Monitor speaker volume.
- Start/stop communication push button and, in standby, it displays the door panel image.
- Door release push button.
- "Doctor mode" function (automatic door opening).
-  Power supply status LED.
-  "Do not disturb" mode - LED fixed/doctor mode - LED slow blink.
- Different ringtones to identify the origin of the call (door panel, intercom or apartment door).
- Dip switches for setting the monitor address (call code) and end of line.
- Input for external door bell push button.
- Call repeater output (SAR-12/24).

SYSTEM OPERATION

- To make a call, the visitor must press the button of the apartment; an audible sound indicates that the call is being made and LED  will turn on. If vocal synthesis is activated then a "call is in progress" message will indicate a call is being made. At this moment the apartment's monitor receives the call. During the call the visitor can correct his call by pressing a push button corresponding to a different apartment, in which case the original call is cancelled.
- The ring tone lasts for 40 seconds. Without alerting the visitor, their image appears on the master monitor to receive the call. To view the picture on a slave monitor this function must first be activated in the monitor. For kit Villa application: the image appears on the monitor (with code 0 "apartment 1" or monitor with code 16 if the call is in "apartment 2") when receiving the call without the visitor being alerted. If the call is not answered within 40 seconds, LED  will turn off and the channel will be freed.
- To establish communication, press the monitor's push button  and the door panel's LED  will turn on. If the vocal synthesis is enabled the message "you can speak now" will be heard confirming the communication is activated.
- Communication will last for one and a half minutes or until button  is pressed again. When communication has finished, LEDs  and  will turn off and the channel will be freed. If vocal synthesis is activated, a "Communication is finished" message will indicate that the call is over.
- To open the door, press button  during the call or communication processes: one press will activate the lock release for five seconds and LED  will also turn on for five seconds. If vocal synthesis is activated, a "Door is open" message will be indicated on the door panel.
- The descriptions of the function push buttons are found on page 4.

MONITOR DESCRIPTION

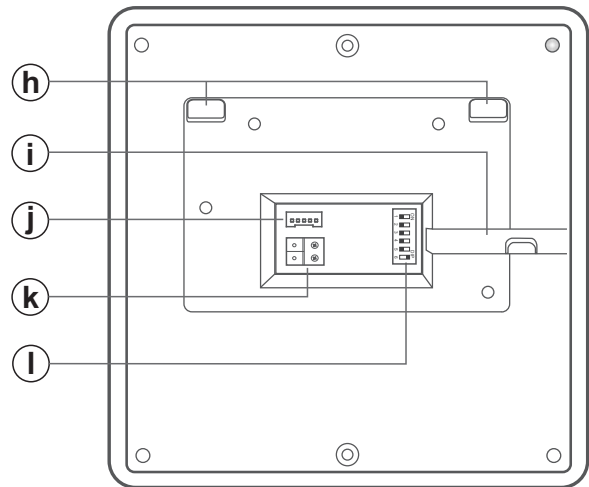
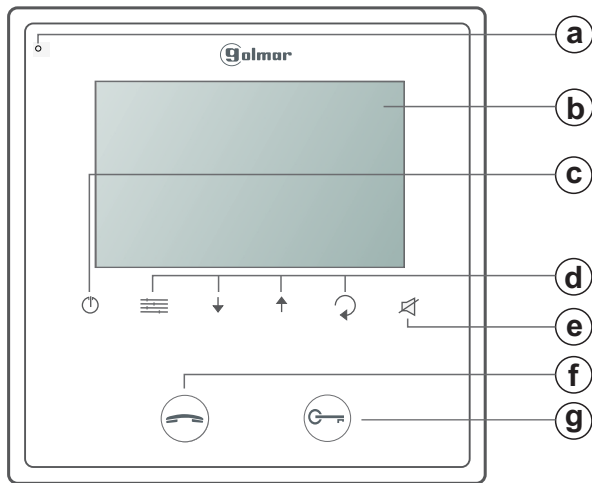

- a. Microphone.
- b. 4.3" TFT colour screen.
- c. Close push button.
- d. Menu push buttons.
- e. "Do not disturb" push button/indicator.
- f. Start/stop communication **function push button**.
During standby: Display door panel image.

- g. Door release **function push button**.
During standby: Press for 10 seconds to activate/deactivate the "doctor mode" function (function code [9018] must be activated).
- h. Attachment holes.
- i. Horizontal cable input.
- j. Connector.
- k. BUS connection terminals.
- l. Configuration DIP switch.

Menu push buttons and status LEDs:

- Menu access and function selection push button.
- Menu scroll down push button.
- Menu scroll up push button.
- Menu back push button.

- Power supply **status LED**.
Push button: End call/communication.
During standby: Enter/exit menu mode.
- "Do not disturb" function access push button.
LED on: "do not disturb" mode activated.
LED blinking: "doctor mode" activated.
LED off: function not activated.

Installation terminals and dip switch:

Connection terminals:

- L1, L2:** BUS connection (non-polarised).
- HZ+, HZ-:** Door bell push button connection.
- CALL REPEATER, GND:** Call repeater connection (SAR-12/24).
(12Vcc/50mA maximum).

Configuration dip switch:

Dip6: Sets the end of line. Set to ON in monitors where the bus cable terminates. Set to OFF only in intermediate monitors.

Dip1 to Dip5: Set the monitor address (addresses 0 to 31).

Switches set to OFF have a value of zero.

The values of the switches set to ON are shown in the enclosed chart.

The monitor code will be the sum of the values of the switches set to ON.

Value chart

Switch number:	1	2	3	4	5
ON value:	1	2	4	8	16



Example: 0 + 0 + 4 + 0 + 16 = 20

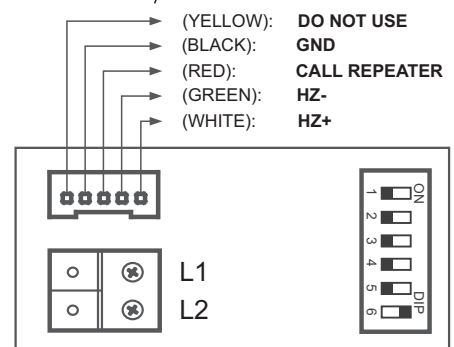
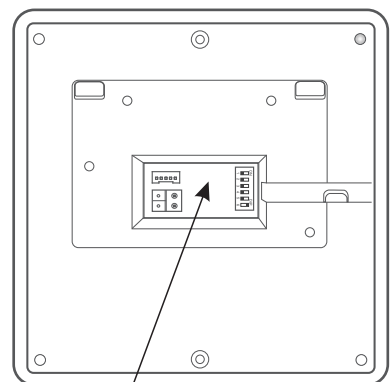

INSTALLATION OF THE MONITOR IN A SURFACE BOX

Avoid dusty or smoky environments or locations near sources of heat.

Positioning the surface box:

The upper part of the surface box must be placed at a height of 1.60m. The minimum distance between the sides of the surface box and the closest object must be 5cm.

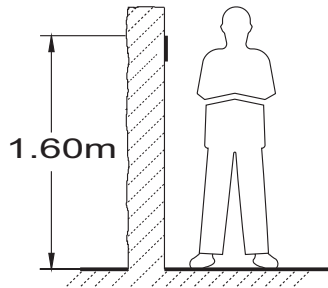

Fixing the monitor's surface box to the wall:

Fix the monitor's surface box to the wall by drilling two 6mm diameter holes and using the screws and plugs supplied with the monitor.

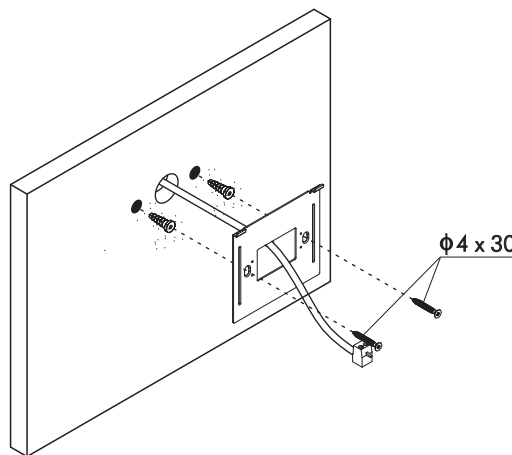

Positioning the monitor:

Connect the cables to the monitor (see page 4), position the monitor perpendicular to the terminal block ensuring that the holes in the base of the monitor line up with those on terminal block ① and then move the monitor towards terminal block ② until the monitor is fixed with the magnets located on monitor ③.

Remember to remove the protective covering from the front of the monitor once installation has been completed

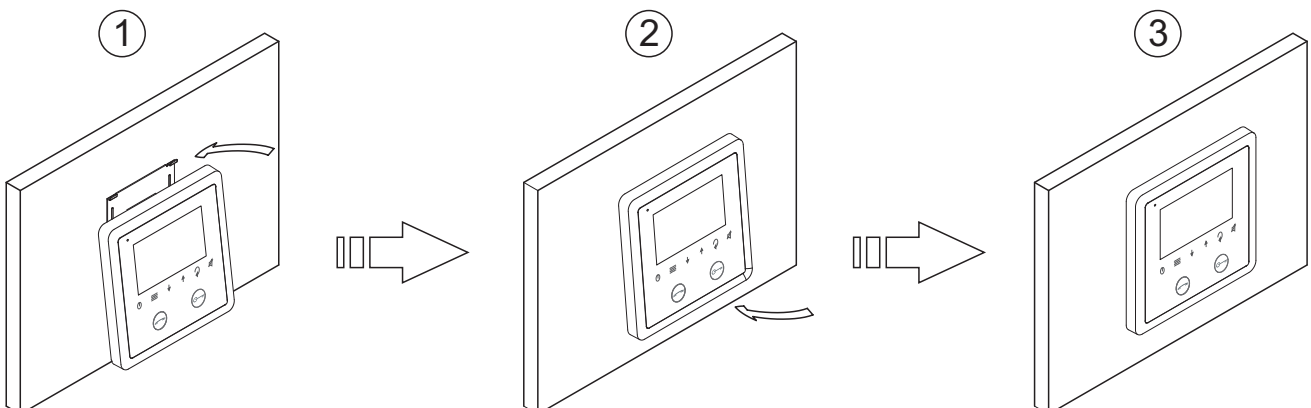

INSTALLATION OF THE MONITOR IN AN EMBEDDING BOX

Avoid dusty or smoky environments or locations near sources of heat.

Positioning the embedding box:

Make a hole in the wall to position the top of the universal embedding box at a height of 1.60m from the ground. The minimum distance between the embedding box and the closest object must be 5 cm.

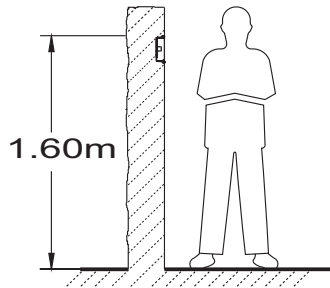

Positioning the embedding box and mounting the terminal block:

Pass the cable through the hole made in the embedding box. Embed the box and ensure that it is level and flush. Fix the terminal block of the monitor with the screws supplied with the embedding box.

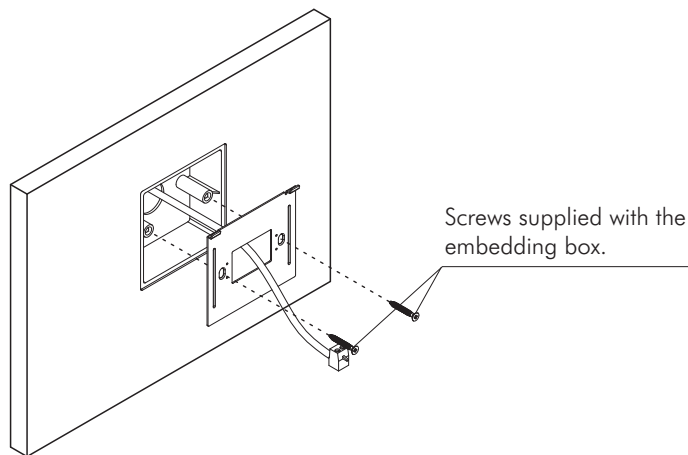

Positioning the monitor:

Connect the cables to the monitor (see page 4), position the monitor perpendicular to the terminal block ensuring that the holes in the base of the monitor line up with those on terminal block ① and then move the monitor towards terminal block ② until the monitor is fixed with the magnets located on monitor ③ .

Remember to remove the protective covering from the front of the monitor once installation has been completed.

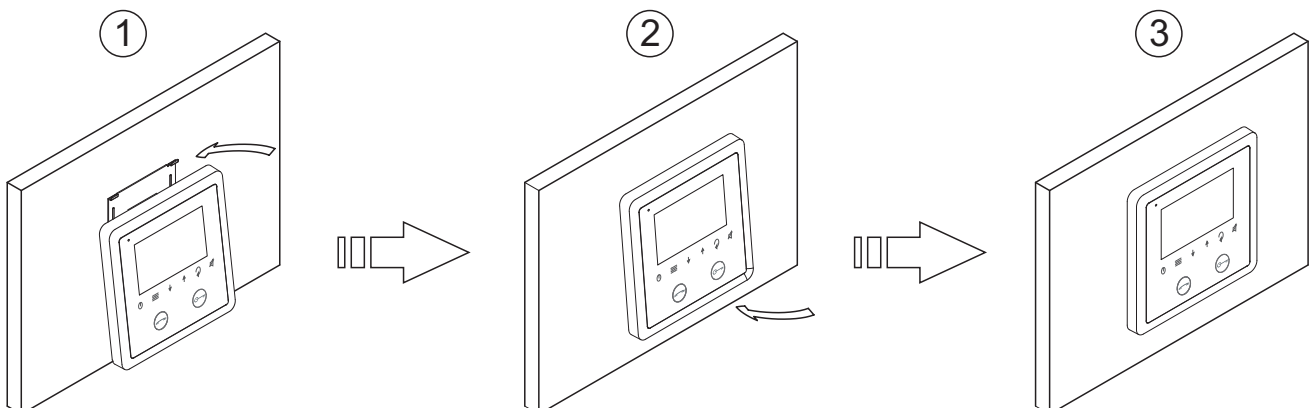

OPERATION

Monitor description upon receiving a call and during communication:

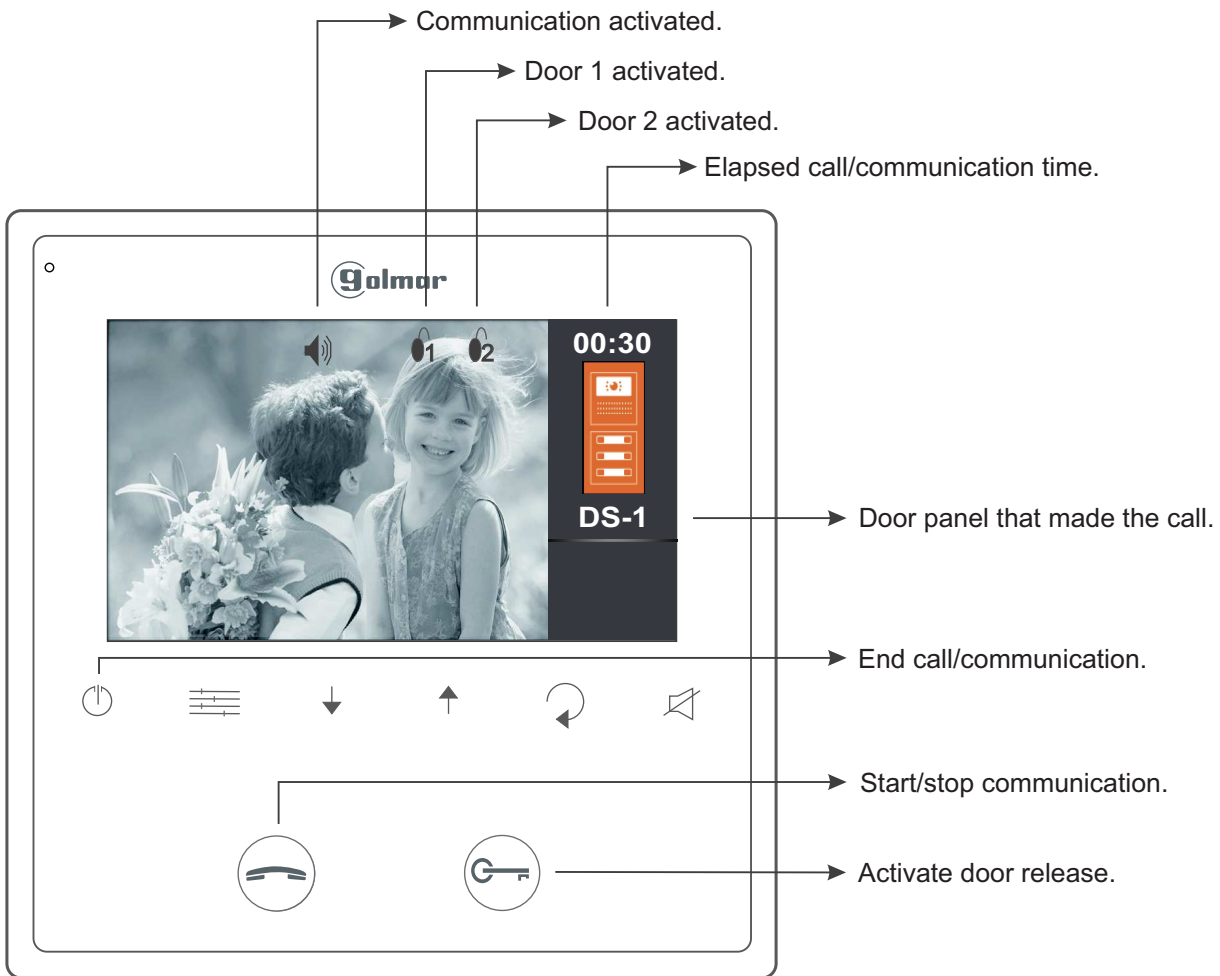

1.1 Receiving a call from the door panel:

When a call is received, the monitor(s) will play a melody and show the door panel image on the main monitor without alerting the visitor. If the call is not answered within 40 seconds the monitor returns to standby.



 To open the door, press the door release push button during the call: one press will activate the lock release for 5 seconds.

OPERATION

Continued from the previous page.

1.2 The call is unanswered (resident unavailable):

When a call is received, the monitor(s) will play a melody and show the door panel image on the main monitor without alerting the visitor. If the call is not answered within 40 seconds the monitor returns to standby.



1.3 Ending a call from the door panel:

When a call is received, the monitor(s) will play a melody and show the door panel image on the main monitor without alerting the visitor. To end the call, press push button .

To open the door, press push button  during the call process: one press will activate the lock release for 5 seconds.



 To open the door, press the door release push button during the call: one press will activate the lock release for 5 seconds.

1.4 Answering a call from the door panel:

When a call is received, the monitor(s) will play a melody and show the door panel image on the main monitor without alerting the visitor. To answer the call, press push button .

Communication will last for one and a half minutes or until button  is pressed again.

To open the door, press button  during the communication or call processes: one press will activate the lock release for 5 seconds.

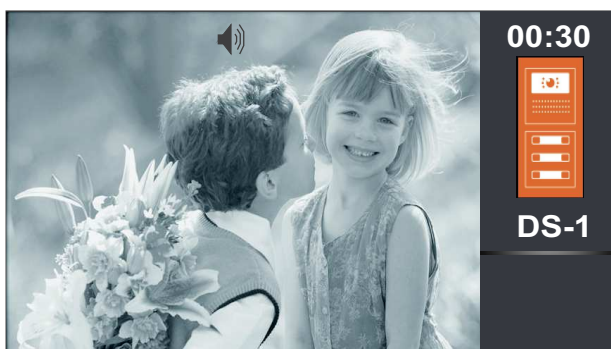

 Start/stop communication.

 To open the door, press the door release push button during the communication or call processes: one press will activate the lock release for 5 seconds.

OPERATION

Continued from the previous page.

1.5 “Doctor mode” function (automatic door opening):

Description:



The “doctor mode” function allows lock release 1 to activate automatically 6 seconds after making a call from the door panel without having to establish communication or pressing door release push button . The main monitor will display the door panel image without alerting the visitor. The call ends after 40 seconds and the channel is freed.

Enabling “doctor mode”:



To enable doctor mode, enter function code [9018] in the installer setup (see pages 24 and 25).



Activating “doctor mode”:

To activate doctor mode, the monitor must be in standby mode. Then press push button  for 10 seconds. Status LED  will blink to indicate that the doctor mode function is activated.

Deactivating “doctor mode”:





To deactivate doctor mode, the monitor must be in standby mode. Then press push button  for 10 seconds. Status LED  will turn off to indicate that the doctor mode function is deactivated.

Important:





When activating “Do not disturb” mode (with the monitor’s “doctor mode” activated), the status LED will change from blinking to fixed and the “doctor mode” function will be cancelled.

When deactivating “Do not disturb” mode (with the monitor’s “doctor mode” activated), the status LED will blink and the “doctor mode” function will be reactivated.

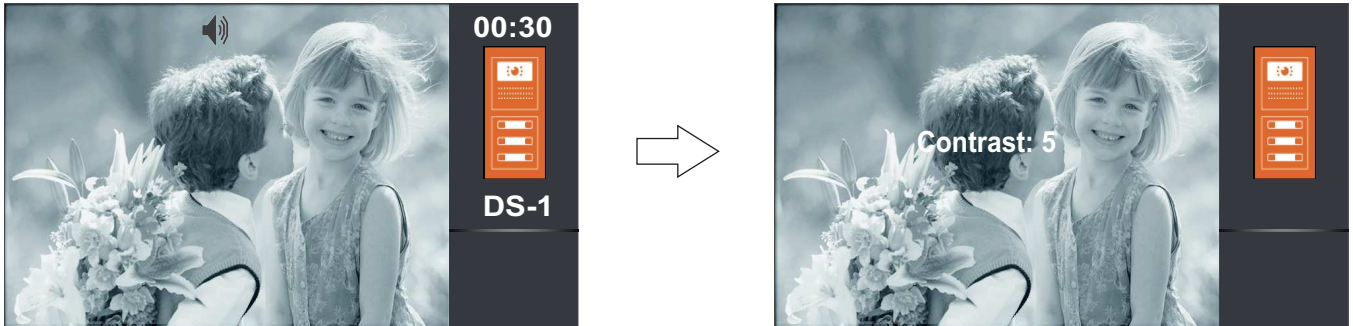



SCREEN AND VOLUME SETTINGS MENU

To adjust contrast, the monitor must be in communication or auto switch-on mode. Then press push button  to display the “Contrast” option on screen. Using menu push buttons  and , select the required contrast level. Press push button  to change the next option, “Brightness”, or press  to exit the settings menu.

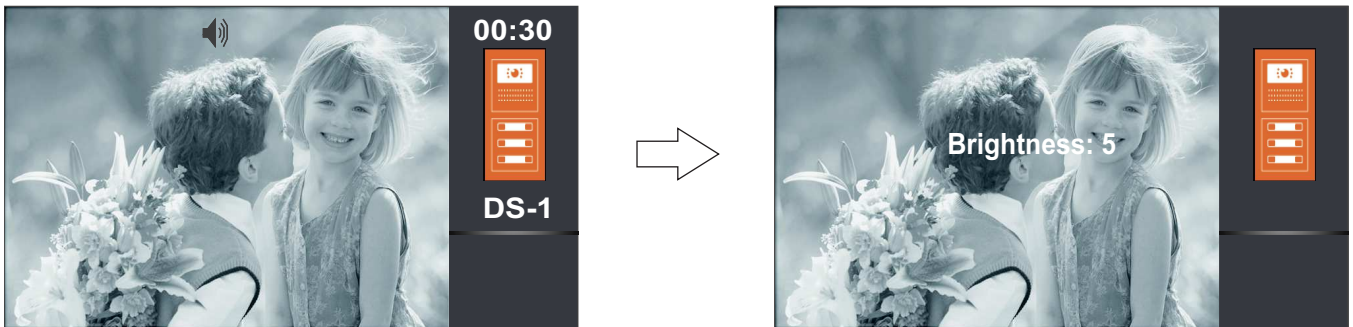





To adjust brightness, the monitor must be in communication or auto switch-on mode. Then press push button  repeatedly until option “Brightness” is displayed on screen. Using menu push buttons  and , select the required brightness level. Press push button  to change the next option, “Colour”, or press  to exit the settings menu.

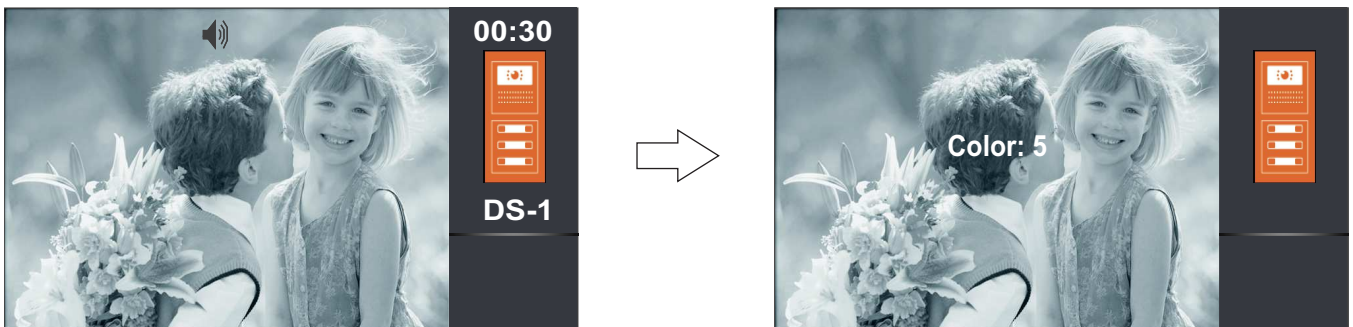

To adjust colour, the monitor must be in communication or auto switch-on mode. Then press push button  repeatedly until option “Color” is displayed on screen. Using menu push buttons  and , select the required colour level. Press push button  to change the next option, “Volume”, or press  to exit the settings menu.





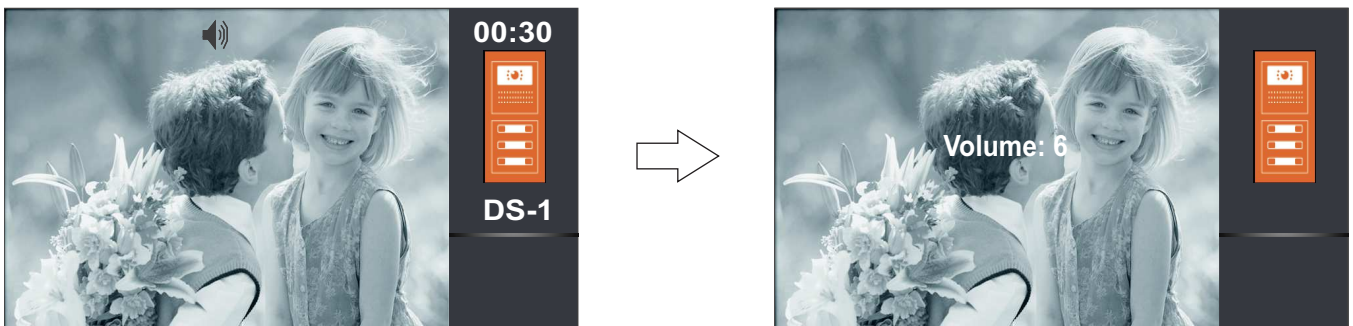

To adjust communication volume, the monitor must be in communication or auto switch-on mode. Then press push button  repeatedly until option “Volume” is displayed on screen. Using menu push buttons  and , select the required volume level. Press push button  to return to option “Brightness” or press  to exit the settings menu.



USER MENU

Description of the menu push buttons:





-  Menu access and function selection push button.
-  Menu scroll down push button.
-  Menu scroll up push button.
-  Menu back push button.
-  Menu exit push button.

To access the menu, the monitor must be in standby. Then press menu push button  to display the first options screen of the main menu.

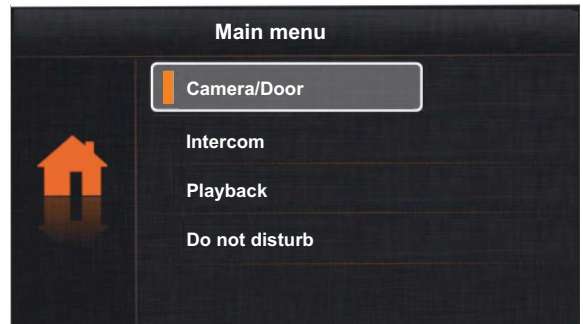
First menu screen



Use menu push buttons  and  to scroll through the different options and access the second screen of the main menu.

First menu screen

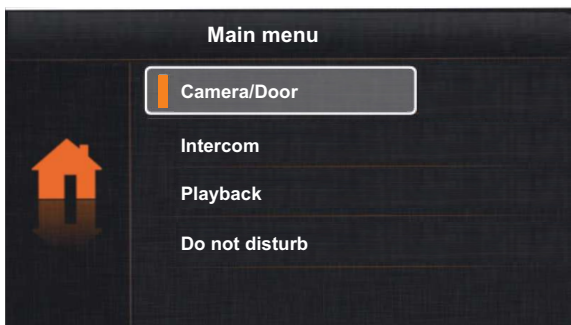

Second menu screen

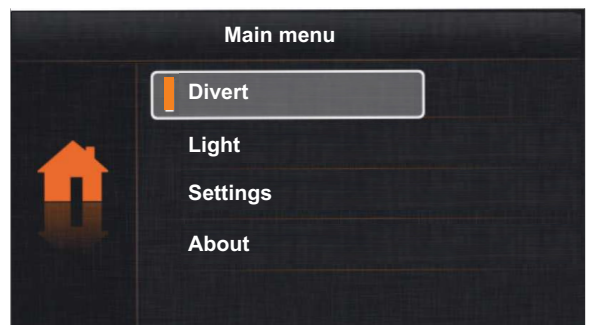

USER MENU

Continued from the previous page.

1. Displaying door panel/camera images:

1.1 To display the image from one of the installed door panels, use push buttons \uparrow and \downarrow to go to option "Camera/Door" and press push button \equiv . The following selection screen will be displayed. Go to the option corresponding to door panel "DS" from which to visualise an image.

First menu screen

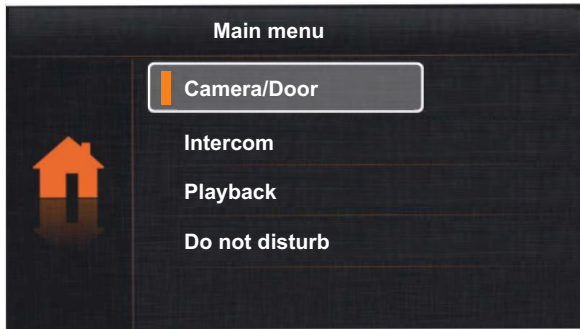

Selection screen



The following screen will display the image from the selected door panel with address 1, it will also indicate the selected door panel 'DS-1' and the elapsed connection time.

The connection will last for 30 seconds or until option \curvearrowright is pressed.

To establish audio and video communication with the selected door panel press push button \odot . The screen will display symbol 🔊 . Communication will last for one and a half minutes or until push button \odot is pressed again or option \curvearrowright is pressed.

To open the door, press push button \odot during the image display or communication processes: one press will activate the lock release for 5 seconds.



\rightarrow This symbol is displayed only when communication mode is enabled.

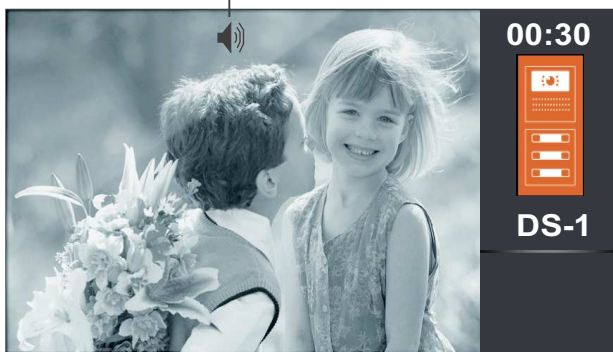

USER MENU

Continued from the previous page.

1.2 To display the image from one of the installed cameras (D-CAM-GB2 module required), use push buttons ↑ and ↓ to go to option “Camera/Door” and press push button . The following selection screen will be displayed. Use push buttons ↑ and ↓ to go to the option corresponding to camera “CM” from which to visualise an image.

First menu screen

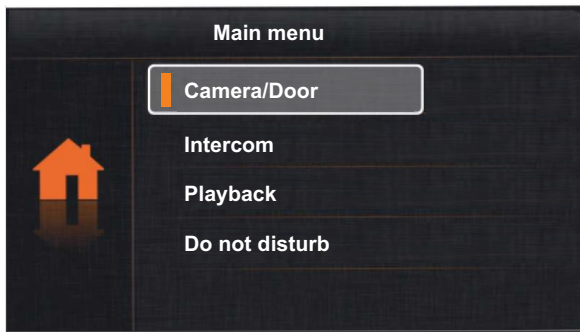

Selection screen



The following screen will display the image from the selected camera with address 1, it will also indicate the selected camera 'CM-1' and the elapsed connection time. The connection will last for 30 seconds or until option  is pressed.



USER MENU

Continued from the previous page.

2. Intercom calls:

Use push buttons \uparrow and \downarrow to go to option "Intercom" and press push button \equiv . The following selection screen will be displayed.

First menu screen

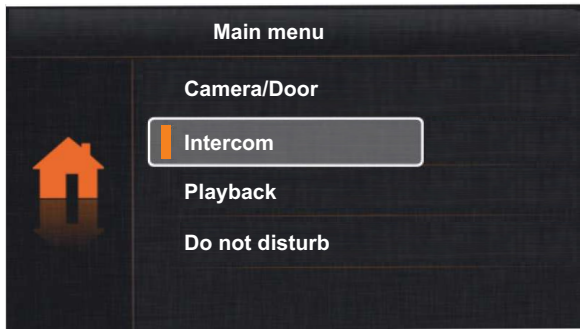

Selection screen

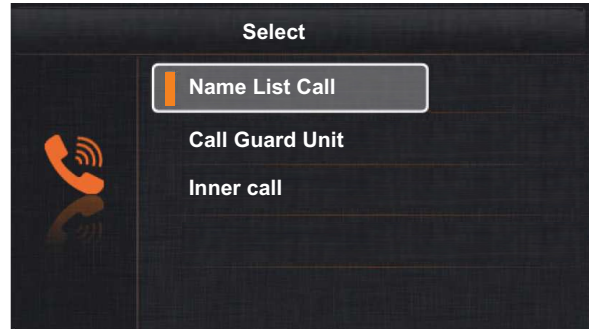

2.1 To access the intercom calls between apartments function, use push buttons \uparrow and \downarrow to go to option "Name List Call" and press push button \equiv . The following selection screen will be displayed. Use push buttons \uparrow and \downarrow to select the apartment to be called.

IMPORTANT: Activate function codes [8017] and [9015] in the monitor (see "installer setup" on pages 24 and 25).

Selection screen

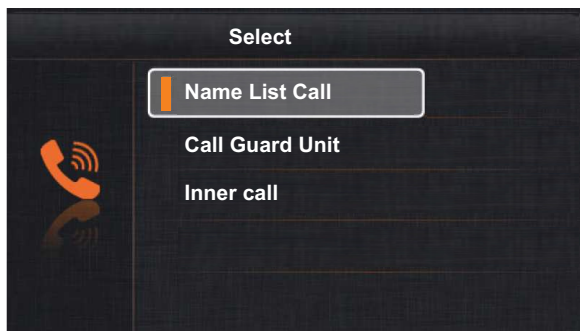

"Name List Call" selection screen



Then press push button \equiv to make the call. The following call screen will be displayed indicating the address of the apartment to be called. A long audible tone confirms the call is being made. A series of short audible tones indicates the call cannot be made because the unit being called is communicating either with the door panel or another apartment. If the call is being made, press option \curvearrowright to cancel the call.

"Name List Call" selection screen

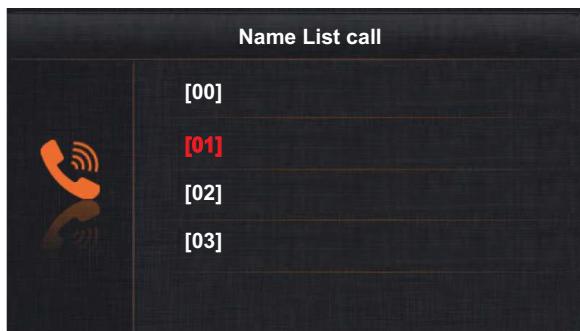



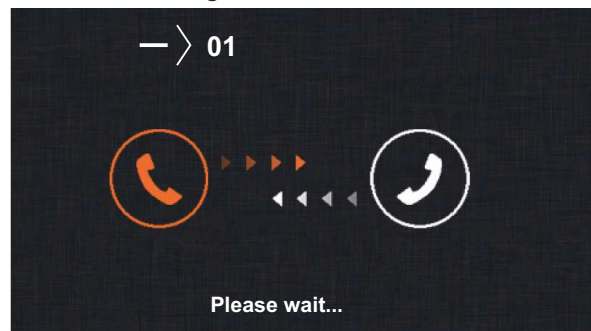

Making an intercom call



USER MENU

Continued from the previous page.

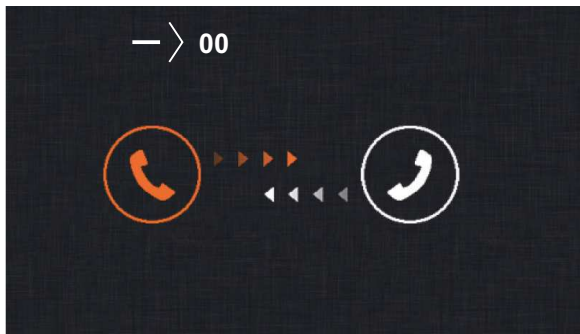

In the called apartment the monitor/s will emit a melody indicating an intercom call and display the address of the apartment making the call. Press push button  to accept the call and establish communication or press option  to cancel it. If the call is accepted, communication will last for one and a half minutes or until push button  is pressed again or option  is pressed.

Receiving an intercom call

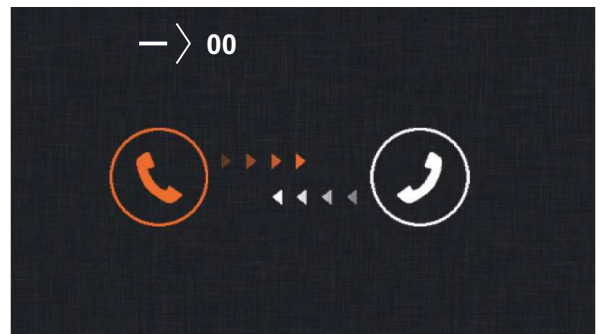

During communication



If during an intercom call there is a call from the door panel to either apartment, the said intercom call will be cancelled. The monitor will emit a melody notifying the incoming call and the image will appear on the master monitor. To establish communication with the door panel press push button  on the monitor. If there are slave monitors in the apartment, press push button  on either of these.

The reproduced acoustic tones are different depending on their provenance, which allows the user to distinguish where the call is made from.

USER MENU

Continued from the previous page.

2.2 To make a call to the building's guard monitor (if there is one), use push buttons \uparrow and \downarrow to go to option "Call Guard Unit" and press push button \equiv . The following call screen will be displayed indicating the address 'GU' of the surveillance monitor to be called. A long audible tone confirms the call is being made. A series of short audible tones indicates the call cannot be made because the surveillance monitor is communicating with another apartment. If the call is being made, press option \curvearrowright to cancel the call.

IMPORTANT: It is recommended to activate function code [8017] in the monitor (see "installer setup" on pages 24 and 25).

Selection screen

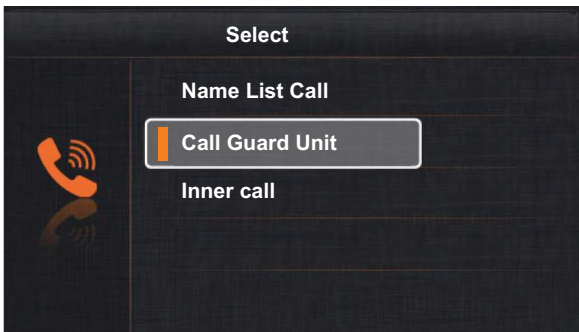

Making an intercom call



The surveillance monitor will emit a melody indicating an incoming call and display the address of the apartment making the call. Press push button \ominus to accept the call and establish communication or press option \curvearrowright to cancel it. If the call is accepted, communication will last for one and a half minutes or until push button \ominus is pressed again or option \curvearrowright is pressed.

Receiving an intercom call

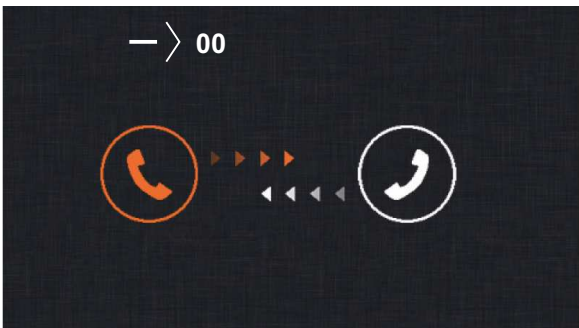

During communication

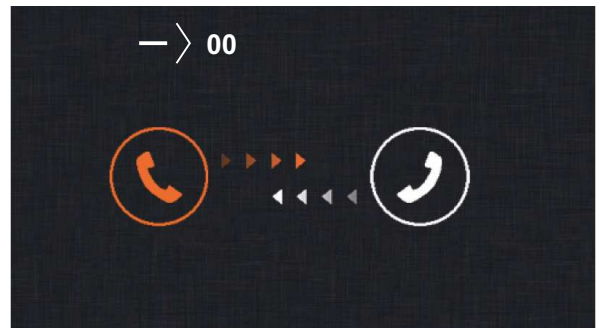

If an apartment receives a call from the door panel while calling or communicating with the surveillance monitor, the call to the surveillance monitor will be cancelled. The apartment's monitor will emit a melody notifying the call from the door panel and the image will appear on the master monitor. To establish communication with the door panel press push button \ominus on the monitor. If there are slave monitors in the apartment, press push button \ominus on either of these.

The reproduced acoustic tones are different depending on their provenance, which allows the user to distinguish where the call is made from.

USER MENU

Continued from the previous page.

2.3 To access the intercom calls within an apartment function, use push buttons \uparrow and \downarrow to go to option “Inner call” and press push button \equiv . The following call screen will be displayed, a long audible tone confirms the call is being made. A series of short audible tones indicates the call cannot be made because a monitor in the apartment is communicating with the door panel. If the call is being made, press option \curvearrowright to cancel the call.

IMPORTANT: It is recommended to activate function code [8017] in the monitor (see “installer setup” on pages 24 and 25).

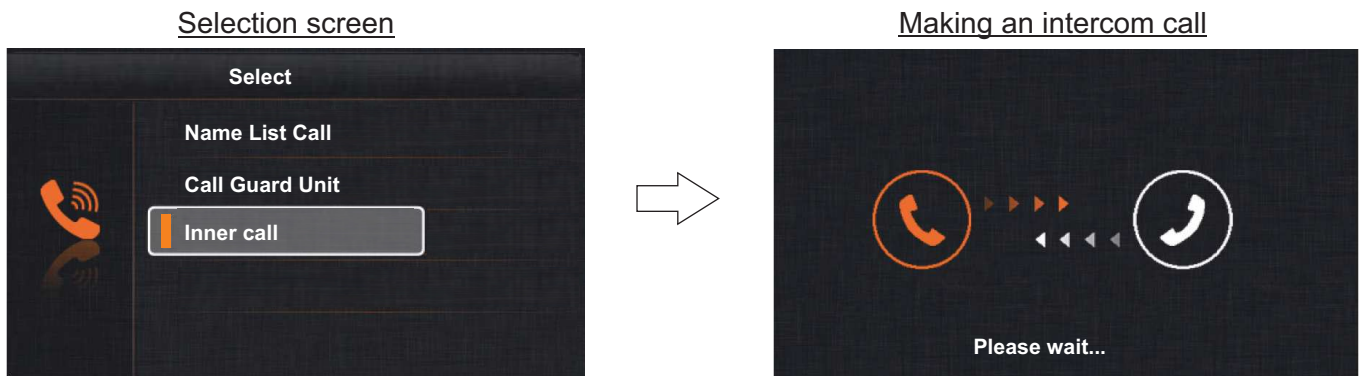

A melody coming from the rest of the monitors in the apartment indicates an incoming intercom call. Press push button \ominus to accept the call and establish communication or press option \curvearrowright to cancel it. If the call is accepted, communication will last for one and a half minutes or until push button \ominus is pressed again or option \curvearrowright is pressed.

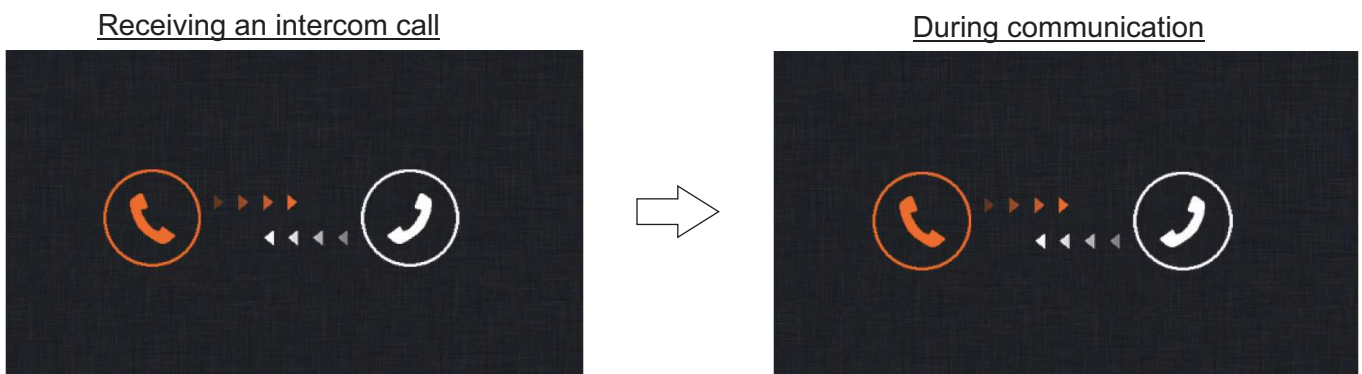

If during an intercom call there is a call from the door panel, the said intercom call will be cancelled. The monitor will emit a melody notifying the incoming call and the image will appear on the master monitor. To establish communication with the door panel press push button \ominus on the monitor. If there are slave monitors in the apartment, press push button \ominus on either of these.

if during an intercom call there is a call from another apartment, the said intercom call will be cancelled. The monitor will emit a melody notifying the incoming call and display the address of the apartment making the intercom call, (see “Intercom calls between apartments” page 15).

The reproduced acoustic tones are different depending on their provenance, which allows the user to distinguish where the call is made from.

USER MENU

Continued from the previous page.

3. Do not disturb mode:

Use push buttons \uparrow and \downarrow to go to option "Do not disturb" and press push button \equiv . The following selection screen will be displayed.

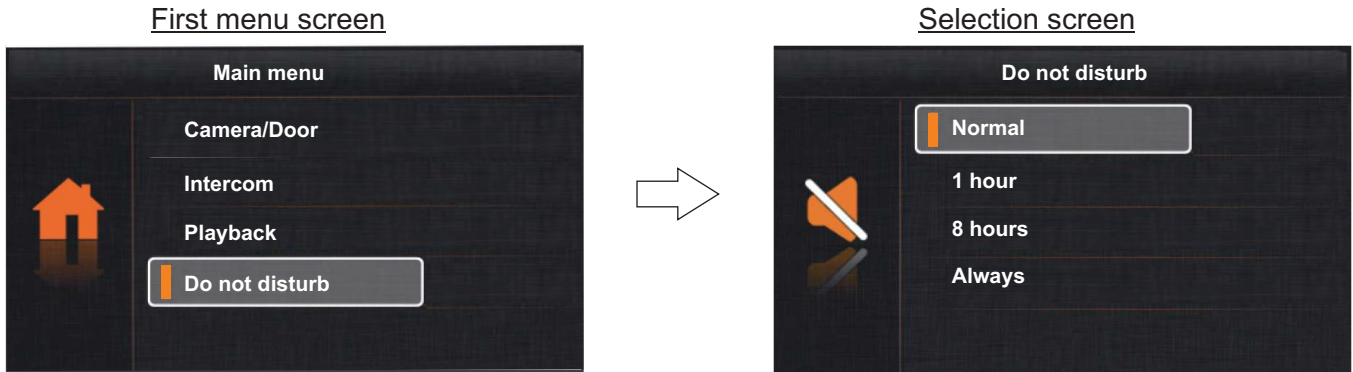

3.1 To activate do not disturb mode, use push buttons \uparrow and \downarrow to go to option "Always" and press push button \equiv . Status LED \triangle will turn on indicating that the function is activated. The monitor will not receive door panel nor intercom calls. To deactivate do not disturb mode, see section "3.4 To deactivate do not disturb mode" on page 20.

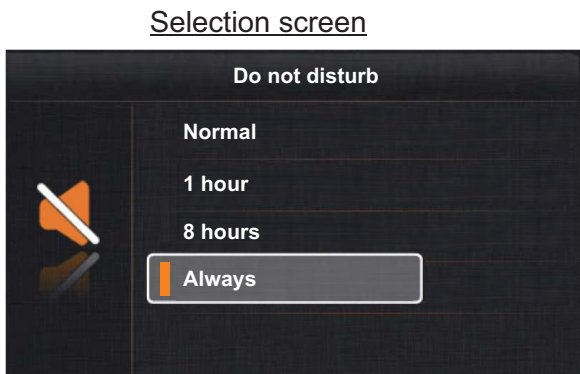

3.2 To activate the timed "1 hour" do not disturb mode, use push buttons \uparrow and \downarrow to go to option "1 hour" and press push button \equiv . Status LED \triangle will turn on indicating that the function is activated. The monitor will not receive door panel nor intercom calls. Do not disturb mode will be activated for 1 hour. To deactivate do not disturb mode before the end of the timed 1 hour, see section "3.4 To deactivate do not disturb mode" on page 20.

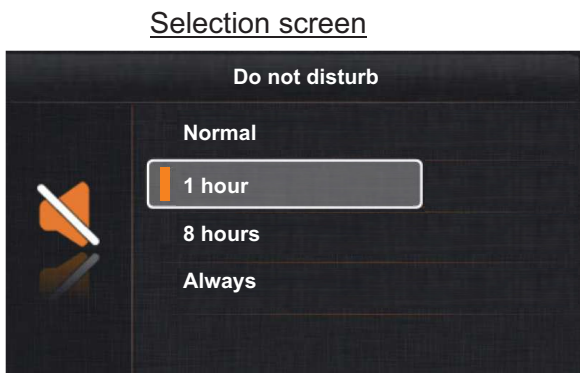

USER MENU

Continued from the previous page.

3.3 To activate the timed “8 hours” do not disturb mode, use push buttons \uparrow and \downarrow to go to option “8 hour” and press push button \equiv . Status LED \triangleleft will turn on indicating that the function is activated. The monitor will not receive door panel nor intercom calls. Do not disturb mode will be activated for 8 hours. To deactivate do not disturb mode before the end of the timed 8 hours, see section “3.4 To deactivate do not disturb mode” on page 20.

Selection screen

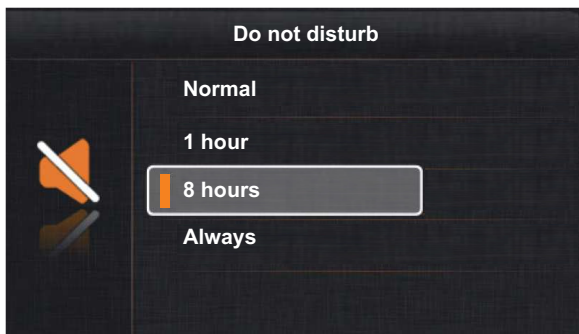

3.4 To deactivate do not disturb mode, press status LED \triangleleft to display the do not disturb “selection screen” and then use push buttons \uparrow and \downarrow to go to option “Normal” and press push button \equiv . Status LED \triangleleft will turn off to indicate that the function is deactivated.

Monitor in standby

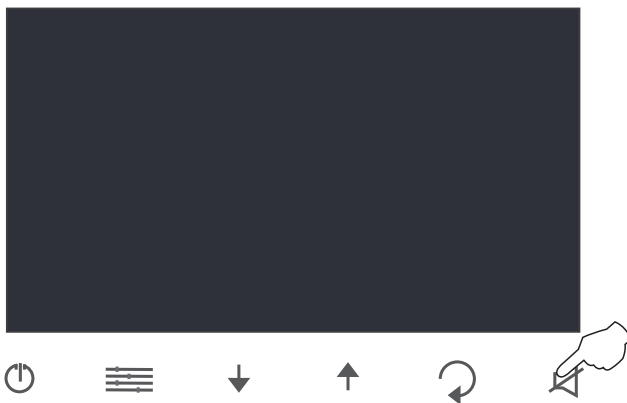

Selection screen

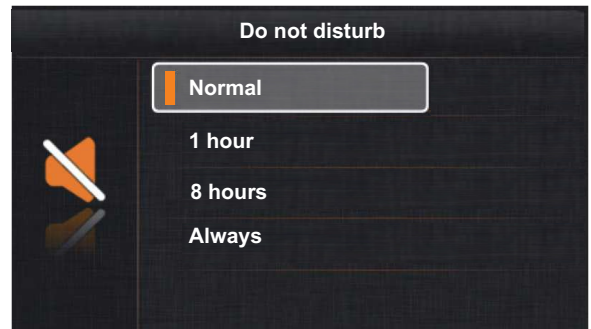

4. Divert call mode (GSM-GB2 module required):

Use push buttons \uparrow and \downarrow to go to option “Divert” and press push button \equiv . The following selection screen will be displayed.

Second menu screen

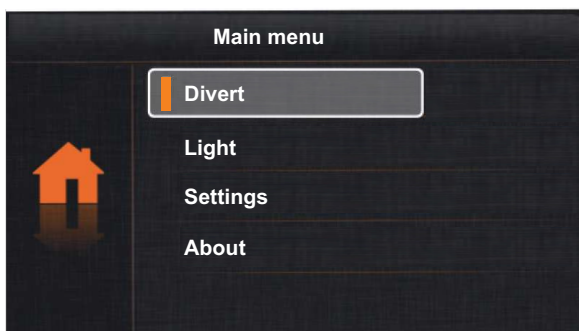

Selection screen

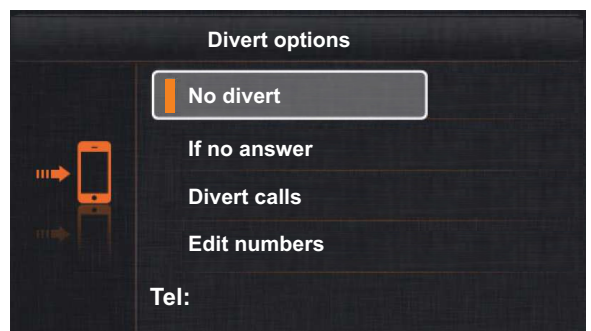

USER MENU

Continued from the previous page.

To edit fixed-line or cellular telephone numbers, use push buttons \uparrow and \downarrow to go to option "Edit numbers" and press button \equiv to display the following telephone number editing screen.

Selection screen

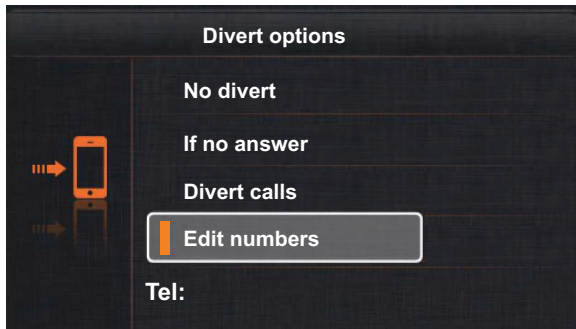

Editing screen

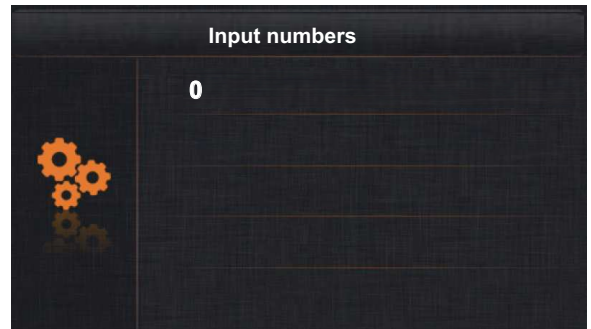

Press push button \equiv and using push buttons \uparrow and \downarrow enter the first telephone number. Then press push button \equiv to enter the next telephone number; repeat the previous steps until the complete telephone number has been entered. To save and exit, press option \curvearrowright .

Editing screen

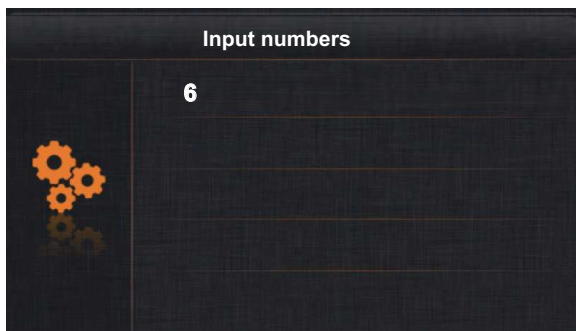

Editing screen

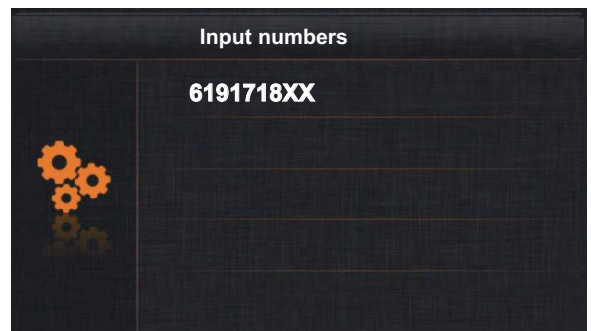

The following editing screen with the edited telephone number will be displayed. **Select the required divert option** using buttons \uparrow and \downarrow . Then press push button \equiv and press option \curvearrowright to exit.

Selection screen

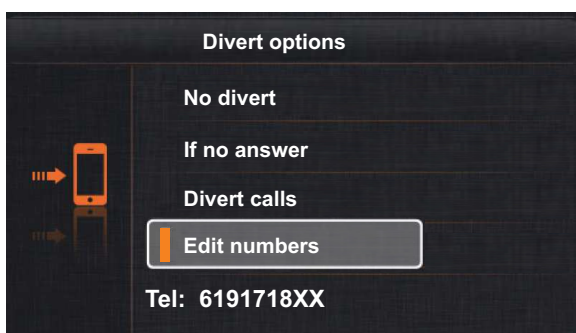

- Door panel call mode, no divert.
- Door panel call mode, divert if not answered within 30 seconds.
- Door panel call mode, immediate divert.
- Edit the fixed-line or cellular telephone number.

The second menu screen will be displayed with icon 🏠 if the selected option is with divert.

Second menu screen

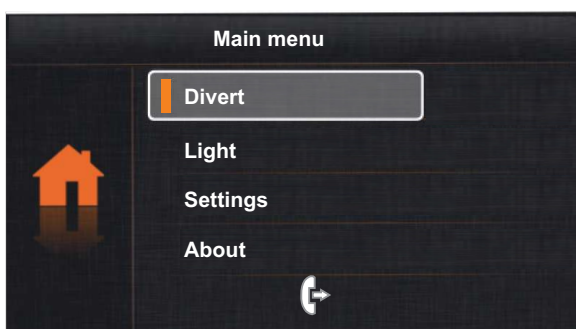

USER MENU

Continued from the previous page.

5. Settings (ringtone, ring volume, auto switch-on time and language selection):

Use push buttons \uparrow and \downarrow to go to option "Settings" and press push button \equiv . The first selection screen will be displayed.

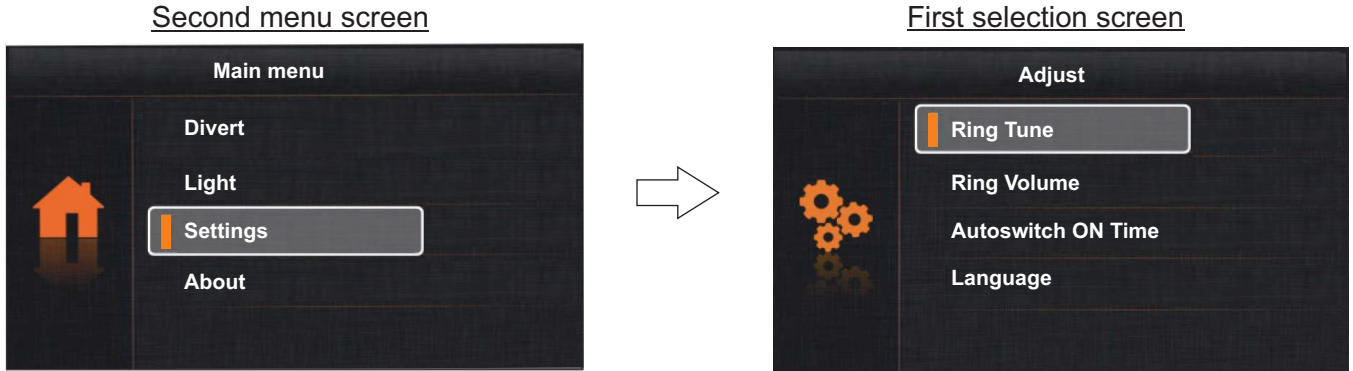

5.1 To access the ringtones, use push buttons \uparrow and \downarrow to go to option "Ring Tune" and press push button \equiv . The second selection screen will be displayed.

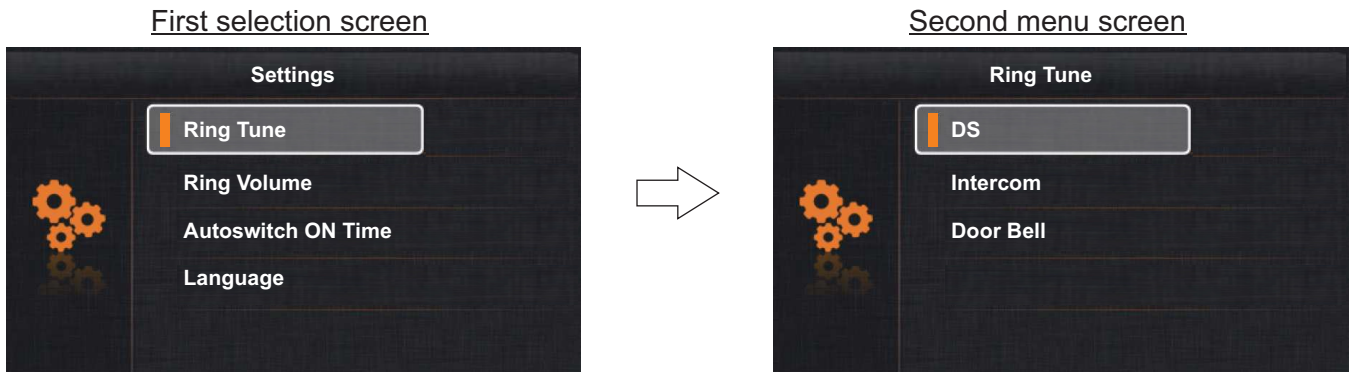

To change the door panel and intercom ringtones and the door bell, use push buttons \uparrow and \downarrow to go to the required option and press push button \equiv . The following selection screen will be displayed. Use push buttons \uparrow and \downarrow to select the required ringtone. Press option \curvearrowright to exit and return to the second selection screen.

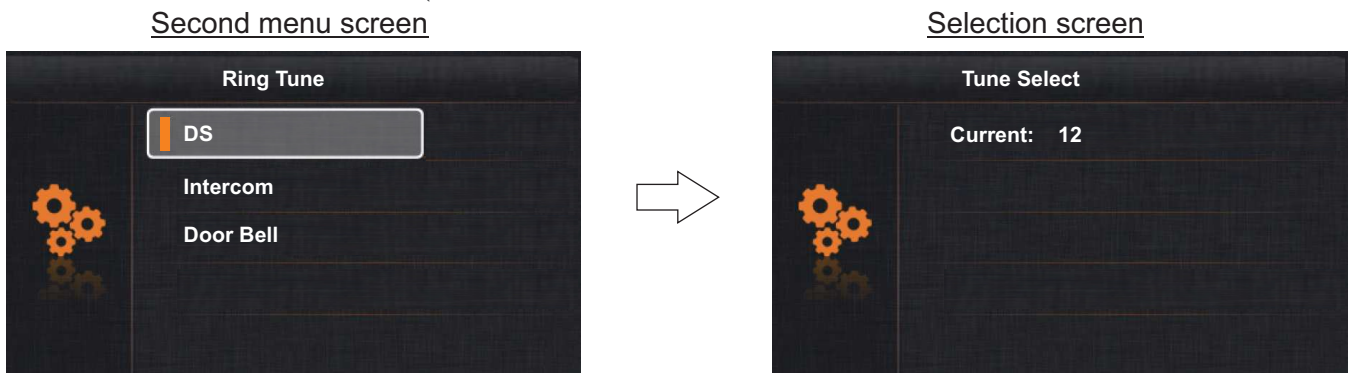

Press option \curvearrowright to go to the first selection screen.

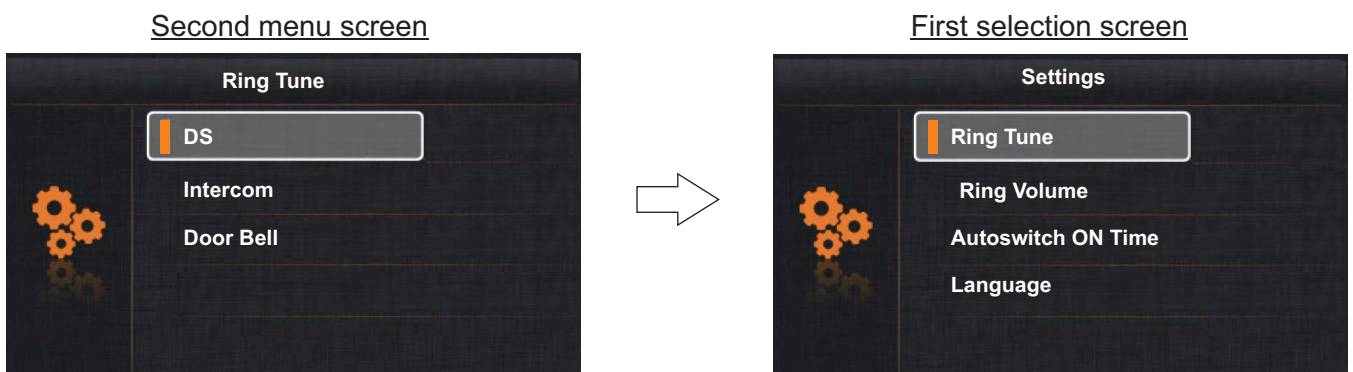

USER MENU

Continued from the previous page.

5.2 To access the ring volume, use push buttons \uparrow and \downarrow to go to option “Ring volume” and press push button \equiv . The following selection screen will be displayed. Use buttons \uparrow and \downarrow to select the ring volume. Press option \curvearrowright to exit and return to the first selection screen.

First selection screen

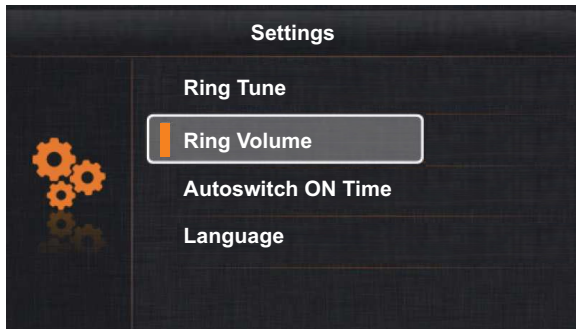

Selection screen

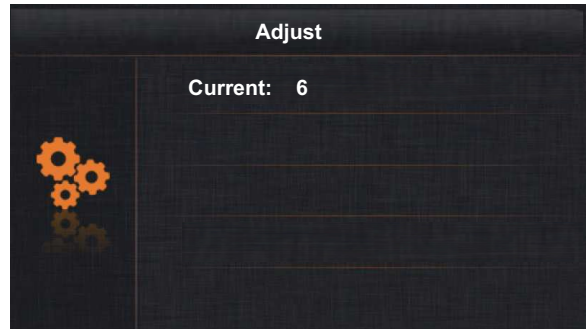

5.3 To access the auto switch-on time setting, use push buttons \uparrow and \downarrow to go to option “Autoswitch ON Time” and press push button \equiv . The following selection screen will be displayed. Use push buttons \uparrow and \downarrow to select the required time. Press option \curvearrowright to exit and return to the first selection screen.

First selection screen

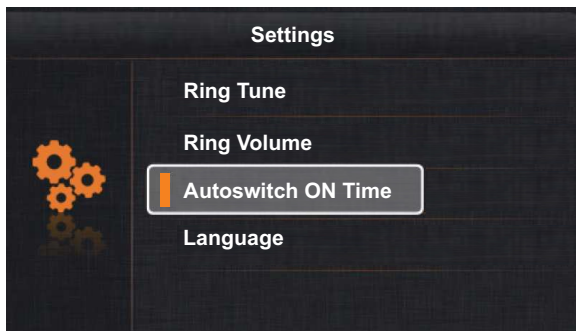

Selection screen

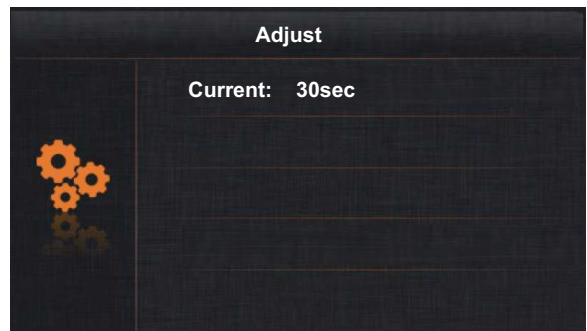

5.4 To access the language selection setting, use push buttons \uparrow and \downarrow to go to option “Language” and press push button \equiv . The following selection screen will be displayed.

First selection screen

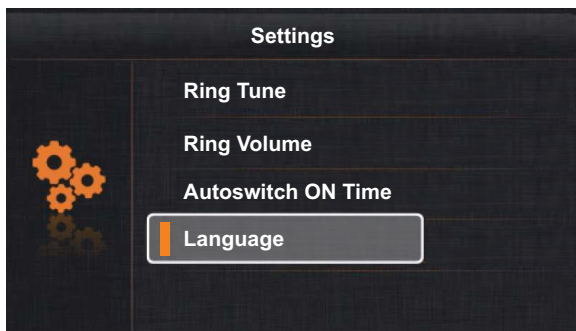

Selection screen



Use push buttons \uparrow and \downarrow to select the language. Press push button \equiv to confirm and then press option \curvearrowright to exit and return to the first selection screen. To return to the menu screen without making a change, press option \curvearrowright .

Selection screen



First selection screen

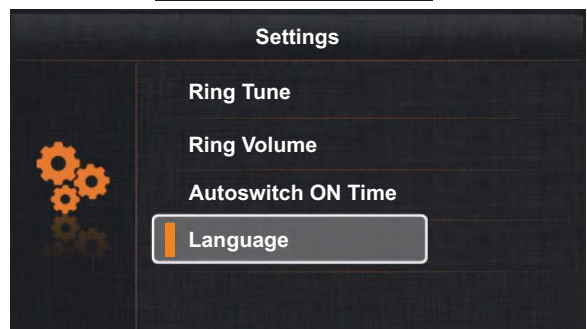

USER MENU

Continued from the previous page.

Press option  to go to the second menu screen.

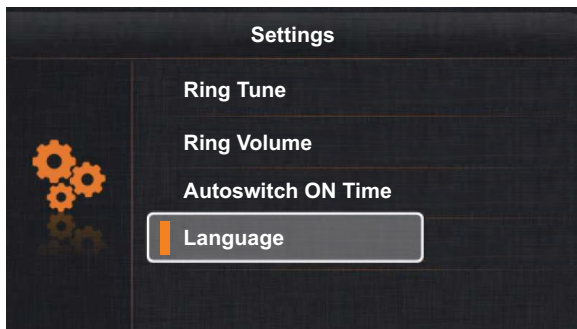

First selection screen

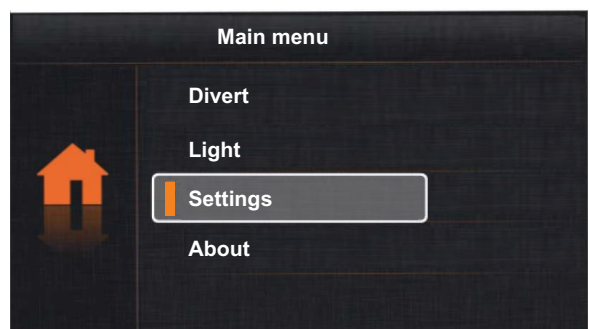

Second menu screen



6. About (information, default settings and installer setup):

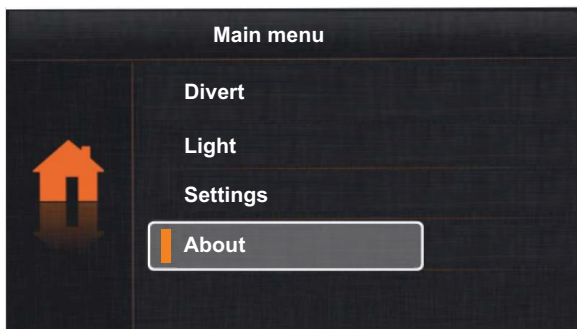

Using push buttons  and  go to option "About" and press push button . The following selection and information screen will be displayed.

Second menu screen



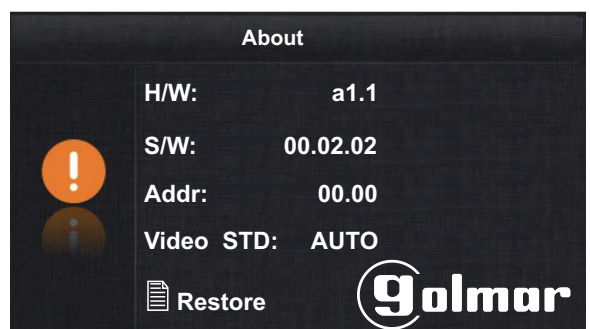

Selection and information screen

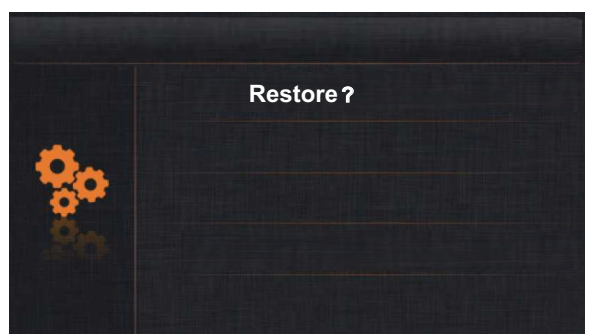
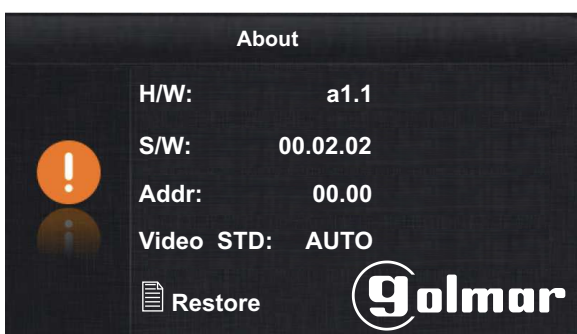

6.1 To access the default settings function, press push button . The following screen will be displayed. Press push button  again to confirm and retain the default settings (ringtone, ring volume and auto switch-on time) in "5. Settings" (see page 22) or press option  to return to the previous screen without executing this function.

Selection and information screen



6.2 To access the installer setup on the monitor's selection and information screen, press push button  for 4 seconds. The following setup screen will be displayed.

Selection and information screen

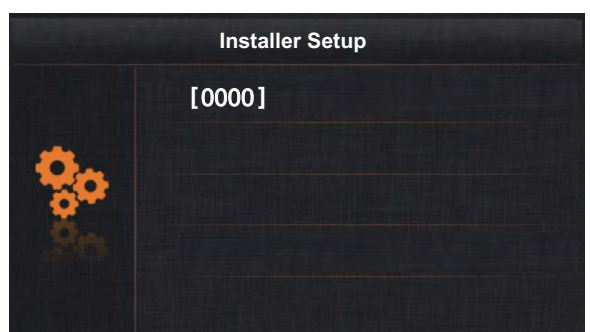
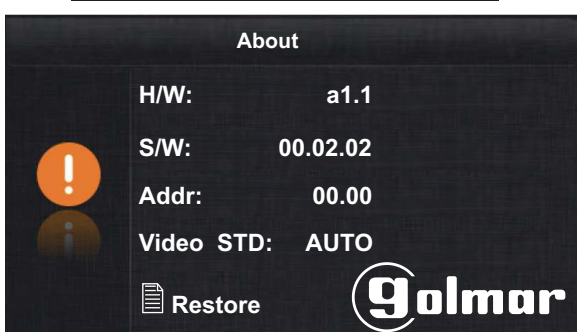

USER MENU

Continued from the previous page.

Use push buttons and to enter the first function code number and then press push button to enter the next function code number; repeat the previous steps until the complete function code number is entered. Confirm the function code entered by pressing push button . To return to the previous screen, press option . (See installer function codes on page 25).

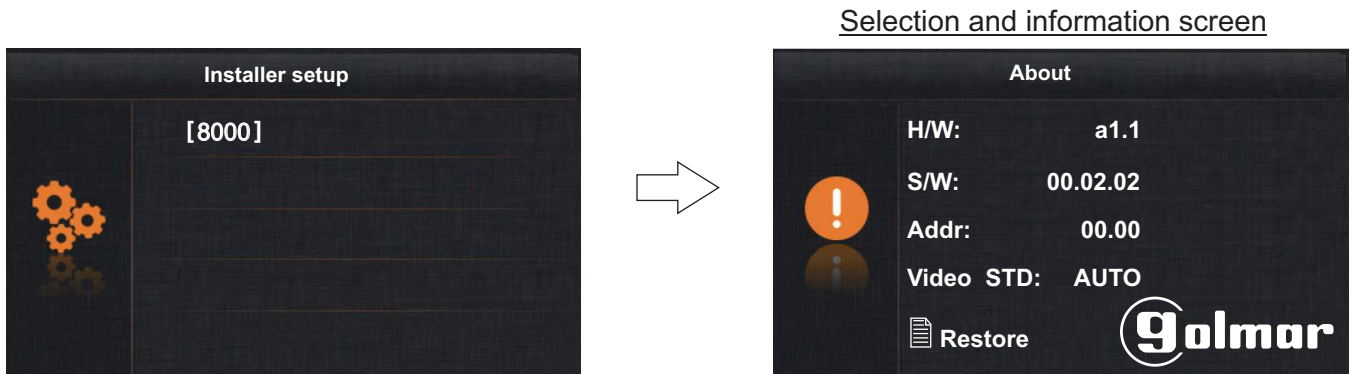

Function codes (installer):

- *[8000]: Master monitor (factory).
- [8004]: Guard monitor.
- [8014]: With second lock release menu.
- [8016]: Not active menu if BUS is busy (default setting).
- (2)[9015]: Intercom calls enabled.
- *[8001] to [8003]: Slave monitor 1 to 3.
- [8005]: Without guard monitor (factory).
- [8015]: Without second lock release menu (default setting).
- (1)[8017]: Yes active menu if BUS is busy.
- [9016]: Intercom calls disabled (default setting).

* Each apartment must have only one master unit: Any further units in the apartment must be configured as slaves.

(1) It is recommended to activate function code [8017]: If there is more than one monitor in the apartment and an intercom call needs to be made.

(1)(2) It is recommended to activate function codes [8017] and [9015]: To make an intercom call between apartments.



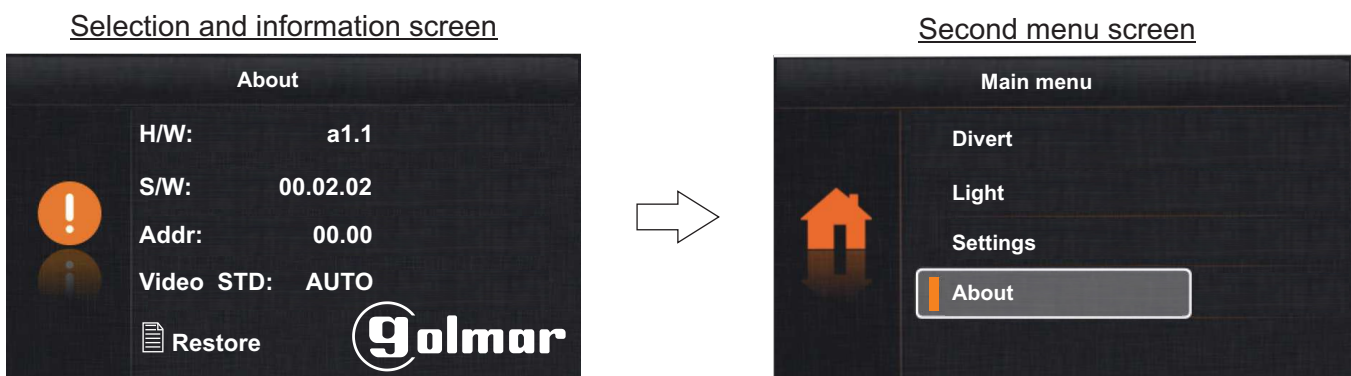

Press option to go to the second menu screen.

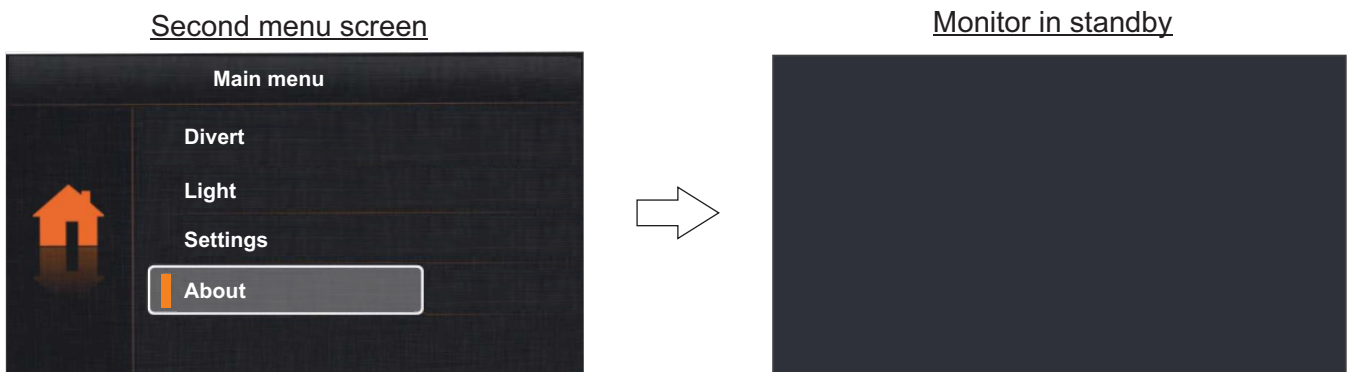



To exit the monitor's user menu function, press option or .

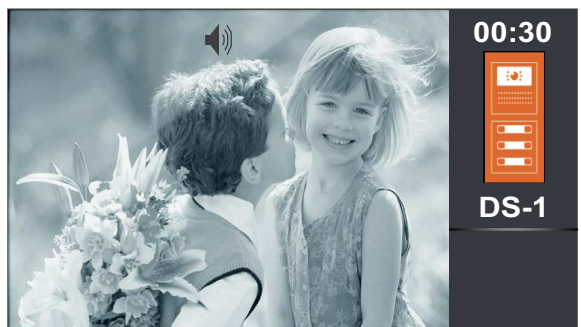

SECOND DOOR RELEASE MENU

To access the second door release menu, press push button  during a call, communication or auto switch-on process. The following selection screen will be displayed. Use push buttons  and  to select door release 1  or door release 2 .



Then press push button .



IMPORTANT: Function code [8014] must be activated in the monitor (see “Installer setup” on pages 24 and 25).

CLEANING THE MONITOR

- Do not use dissolvents, detergents or cleaning products that contain acids, vinegar or abrasive components.
- Use a soft, damp cloth (not wet) that does leave lint behind.
- Always wipe the monitor in the same direction, from top to bottom.
- After cleaning the monitor remove any moisture using a soft, dry cloth that doesn't leave lint behind.

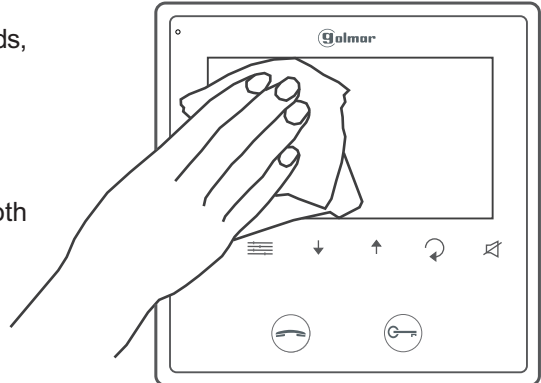



golmar@golmar.es
www.golmar.es



Golmar se reserva el derecho a cualquier modificación sin previo aviso.
Golmar se réserve le droit de toute modification sans préavis .
Golmar reserves the right to make any modifications without prior notice.





USER MENU (ANNEX)

“Playback” menu option (MM-GB2 module and FA-GB2 power supply required):

Description of the menu push buttons:



Menu push buttons and status LEDs:

-  Menu access and function selection push button.
-  Menu scroll down push button.
Manual recording push button: During a call, communication or auto switch-on process.
-  Menu scroll up push button.
-  Menu back push button.

Status LED:
 Fixed: power On.
 Blinking: Door panel call videos yet to be displayed.

Push button:
 Status LED blinking: Press to access the “Playback” menu.
 Status LED fixed: Enter/exit menu mode.





Note: The monitor makes an automatic video recording 6 seconds after receiving a call from the door panel.

Viewing door panel call/camera videos and deleting videos (MM-GB2 module and FA-GB2 power supply required):

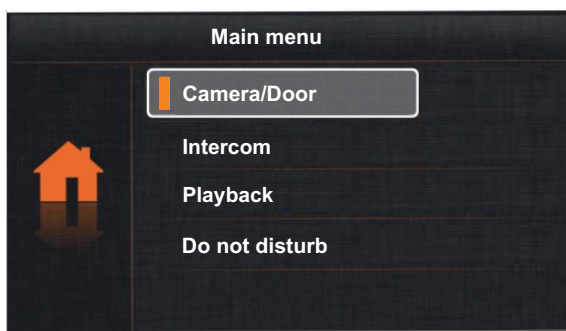
To access the menu, the monitor must be in standby. Then press menu push button  to display the first options screen of the main menu.

First menu screen



To display call/camera videos, use push buttons  and  to go to option “Playback” and press push button . The following selection screen will be displayed. Use push buttons  and  to select the video to display. The duration of each video is 10 seconds.

First menu screen

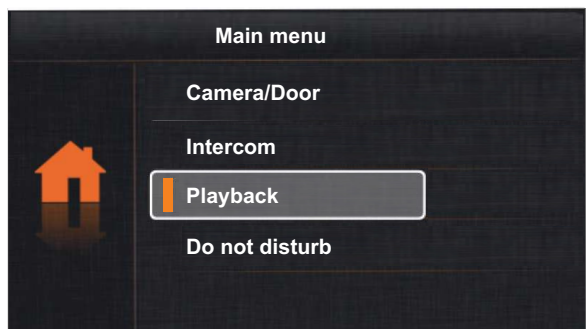



Selection screen



USER MENU (ANNEX)

Continued from the previous page.

To delete the selected video, press option . **“Delete?”** will be displayed on the screen. Press push button  to confirm the deletion or press option  to cancel the deletion and return to the previous screen.

Selection screen



Selection screen



To exit option “Playback” and return to the first menu screen, press push button .

Selection screen

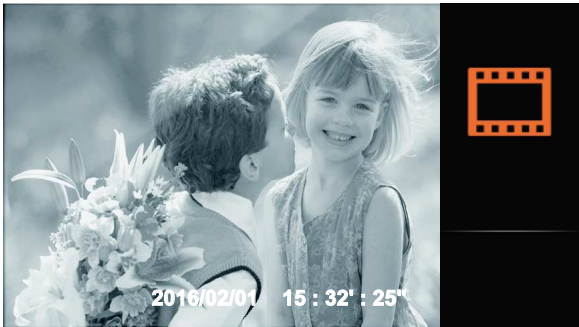

First menu screen

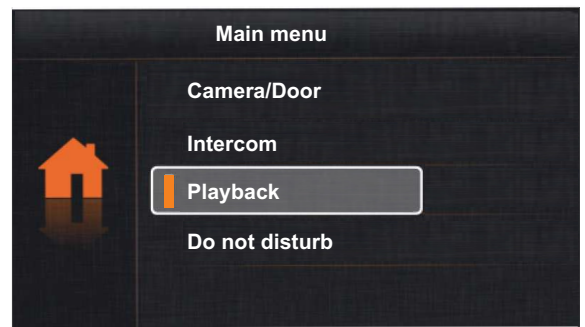





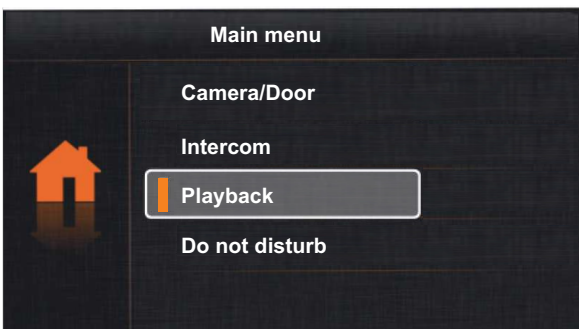

To exit the monitor's user menu function, press option  or .

First menu screen



Monitor in standby



To change the date and time, go to option “Settings” (as shown on page 22) and then press push button  for 3 seconds. The following “Date & Time” settings screen will be displayed. Press push button  to move over the date/time setting and use push buttons  and  to change the values. Press option  to save and then press option  to exit the user menu function.

Settings selection screen

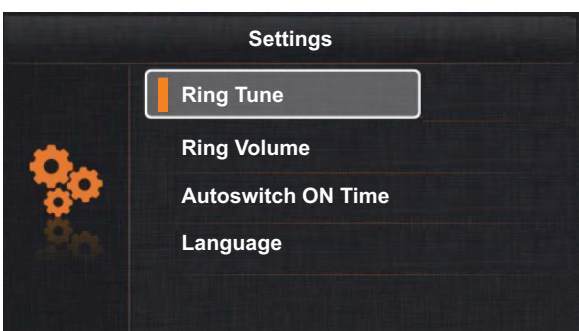

Date and time settings screen

